



Fortis

Technical Manual

Document No. MAN-FOR-0001

Issue L, May 2022

Designed and manufactured by
Güralp Systems Limited
3 Midas House, Calleva Park
Aldermaston RG7 8EA
England

Table of Contents

1 Preliminary Notes	4
1.1 Proprietary Notice	4
1.2 Warnings, Cautions and Notes	4
1.3 Manuals and Software	4
2 Introduction	5
3 Fortis^{PH} – the Post-hole Fortis	7
4 Getting started	10
4.1 Unpacking and packing	10
4.2 Initial testing	10
4.3 Setting the gain	11
4.3.1 To adjust the gain using the switch	11
4.3.2 To adjust the gain using a Güralp Minimus digitiser	13
4.3.3 To adjust the gain using the control lines	14
4.3.4 Gain interaction	14
4.4 Output polarity	15
4.5 Use with third-party digitisers	16
5 Installation	17
5.1 Permanent installations	17

5.2 Temporary installations.....	18
5.3 Installation in Hazardous environments	19
<hr/>	
6 Calibration.....	20
<hr/>	
6.1 Absolute calibration	20
6.2 Relative calibration.....	20
6.3 Calibrating the Fortis	21
<hr/>	
6.3.1 Broadband Noise calibration using Scream and CD24/DM24 digitiser.....	21
6.3.2 Broadband Noise calibration using Affinity digitiser.....	24
6.3.3 White Noise calibration using Minimus	27
6.3.4 Calibration with third-party digitisers	30
<hr/>	
6.4 The calibration pack	30
<hr/>	
6.4.1 The calibration sheet.....	30
6.4.2 Frequency response	31
6.4.3 Obtaining copies of the calibration pack	31
<hr/>	
7 Appendix A – Connector pin-outs	32
<hr/>	
7.1 Fortis instrument connector.....	32
7.2 Fortis ^{PH} instrument connector	33
<hr/>	
8 Appendix B – Certificate of conformance	34
<hr/>	
9 Revision History	35
<hr/>	

1 Preliminary Notes

1.1 Proprietary Notice

The information in this document is proprietary to Güralp Systems Limited and may be copied or distributed for educational and academic purposes but may not be used commercially without permission.

Whilst every effort is made to ensure the accuracy, completeness and usefulness of the information in the document, neither Güralp Systems Limited nor any employee assumes responsibility or is liable for any incidental or consequential damages resulting from the use of this document.

1.2 Warnings, Cautions and Notes

Warnings, cautions and notes are displayed and defined as follows:



Warning: A black cross indicates a chance of injury or death if the warning is not heeded.



Caution: A yellow triangle indicates a chance of damage to or failure of the equipment if the caution is not heeded.



Note: A blue circle indicates indicates a procedural or advisory note.

1.3 Manuals and Software

All manuals and software referred to in this document are available from the Güralp Systems website: www.guralp.com unless otherwise stated.

2 Introduction

The Güralp Fortis is a three-axis, strong-motion, force-feedback accelerometer with an innovative, slim-line design for fast installation in any environment. The system has a flat response to ground acceleration from DC to 100 Hertz and a stable phase response within this passband.

Extremely low noise, a high dynamic range and switchable gain allow the instrument to perform optimally in a wide range of scenarios, providing versatility for all EEW (earthquake early warning) and structural health monitoring applications.



The hard-anodised aluminium casing protects the instrument from water, allowing it to be deployed in a range of environments. Installation is simple, using a single fixing bolt to attach the sensor to a hard surface. If required, you can also level the sensor using its adjustable levelling feet. An integrated bubble-level provides quick visual feedback.

Each accelerometer is delivered with a detailed calibration sheet showing its serial number, measured frequency response, sensor DC calibration levels and the transfer function in poles/zeroes notation.

Optionally, you can use a Güralp Hand-held Control Unit (HCU) and/or breakout box to distribute power and calibration signals to the sensor and to receive the signals it produces. The HCU is available in standard, rack-mounted and water-resistant portable formats.

A version designed for post-hole deployments, the Fortis^{PH}, is also available. See chapter 3 on page 7 for details.



3 Fortis^{PH} – the Post-hole Fortis



The Fortis accelerometer is also available in borehole-specific packaging. This variant is called the Fortis Post-hole, or Fortis^{PH}. The components and electronics inside the sensor are identical to the surface module: the only difference is in the external casing and the connector, which is waterproof to 100 Bar (equivalent to 10 MPa or 1500 psi). See section 7.2 on page 32 for pin-out details.



Note: The Fortis^{PH} is not fitted with the bubble level, adjustable feet, engraved switch and pointers.

The Fortis^{PH} is 125 mm in diameter and 78 mm tall, excluding the connector. An engraved arrow on the top of the casing indicates the direction of sensitivity of the North/South component, so the instrument can be aligned correctly.

Four tapped holes in the lid, situated around the connector, allow the attachment of a lifting bail. The bail is cranked to allow easy access to the connector. When fitted, the top of the bail is around 290 mm above the bottom of the instrument.



Like the Fortis, the centring function allows installation of the accelerometer at up to around 10 degrees of inclination from the vertical axis. When the Fortis^{PH} is powered-up, a centring command is executed automatically in order to null any offset. The centring command can also be sent via software from the Minimus' web-page, using the control in the Setup tab ("Centre Mass" button).

Analogue Sensors			
Analogue to Digital Converter			
Input gain	<input type="text" value="x1.0"/>	Input range	<input type="text" value="+/- 20.48 V"/>
		Input resolution	<input type="text" value="2.441 uV/count"/>
Identification			
Sensor type	<input type="text" value="Guralp Fortis"/>		
Response			
Fortis Range	<input type="text" value="-2.0g; +2.0g"/>	Fortis Loop	<input type="text" value="Normal"/>
Mass Centring			
Centre Mass		Mass Readout Z	<input type="text" value="-0.00375 V"/>
		Mass Readout W	<input type="text" value="-0.00312 V"/>
		Mass Readout E	<input type="text" value="-0.00375 V"/>
Calibration			
Calibration	<input type="text" value="Off"/>	Amplitude	<input type="text" value="100%"/>
		Channel	<input type="text" value="Normal"/>

The physical switch used in the Fortis to set the gain is not accessible in the Fortis^{PH}. The gain is set at ± 2 g by default but it is still possible to change the gain from the Minimus digitiser web page (see section 4.3.2 on page 12 for details).

4 Getting started

4.1 Unpacking and packing

The Fortis is delivered in environmentally friendly, flat-packable, suspension packaging. The packaging is specifically designed for the Fortis and should be re-used whenever you need to transport the sensor. Please note any damage to the packaging when you receive the equipment and unpack on a clean surface. The package should contain the accelerometer, the calibration pack and either a connection cable, if ordered, or a 19-pin free socket, to which you can terminate your own cabling.



Caution: Although the Fortis is a strong motion instrument, it contains sensitive mechanical components which can be damaged by mishandling. If you are at all unsure about the handling or installation of the device, you should contact Güralp Systems for assistance.

- Do not bump or jolt any part of the sensor when handling or unpacking.
- Do not kink or walk on the data cable (especially on rough surfaces such as gravel), nor allow it to bear the weight of the sensor.
- Do not connect the instrument to power sources except where instructed.
- Never ground any of the output signal lines from the sensor.

4.2 Initial testing

Pre-installation testing is most easily accomplished by connecting the Fortis to a Güralp or third-party digitiser, which provides visibility of each individual output.

1. Ensure the gain is set to $\times 2$ (i.e. ± 2 g full scale – see section 4.3 on page 10). This is the default configuration from the factory.
2. Place the Fortis on a flat, horizontal surface, connected to the digitiser and power supply.
3. Open the Live View of preferred software and verify that the steady output voltage is about zero (± 10 mV or ± 9.8 mm/s²) from all three components.
4. Now turn the sensor on its side, propping it carefully to stop it rolling.

5. The vertical output should now read about -5 V , corresponding to -1 g (-9.8 m/s^2).
6. Rotate the Fortis until the "N" indication arrow points vertically upwards.
7. The North/South output should now read $+5\text{ V}$, corresponding to $+1\text{ g}$ ($+9.8\text{ m/s}^2$).
8. Rotate the Fortis until the "N" indication arrow points horizontally.
9. The East/West output should now read $+5\text{ V}$, corresponding to $+1\text{ g}$ ($+9.8\text{ m/s}^2$).

If the performance so far has been as expected, the instrument may be assumed to be in working order and you may proceed to install the unit for trial recording tests. In many cases, there will be a slight offset to the readings – this can be disregarded.

4.3 Setting the gain

The gain of the Fortis can be controlled by a rotary switch, recessed into the base of the instrument, by a configuration setting on the web page of a Güralp Minimus digitiser, or by selectively grounding none, one or both of two control lines, exposed on the main instrument connector.

Pin-out details for the connector are given in Section 7 on page 31.



Note: The Fortis is delivered from the factory with the gain-setting switch in position 3. This results in a full-scale output corresponding to $\pm 4\text{ g}$.

4.3.1 To adjust the gain using the switch

1. Remove the cover screw using a large, flat-bladed screwdriver.



Warning: Instruments are assembled at sea-level. If you are working at altitude, there may be a considerable pressure differential between the outside and the inside of the casing. Take care that the screw does not fly off, which may cause injury.

2. Using a small, flat-bladed screwdriver, turn the exposed switch to one of the four marked positions, as specified in the table below.

Switch position	Amplifier gain	Full-scale (g)
0	8	0.5
1	4	1
2	2	2
3	1	4

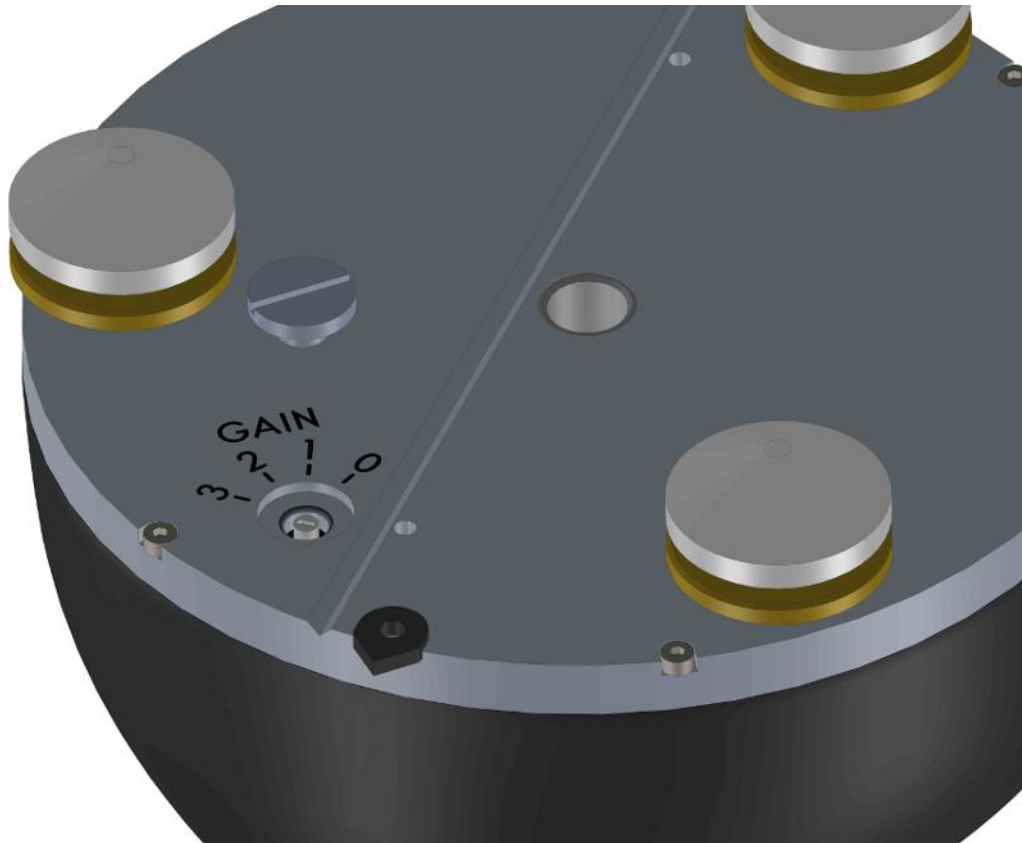

3. Check the cover screw, the 'O'-ring and the mating face on the base of the instrument for any dirt or contamination which may compromise the seal. Clean if necessary.
4. Replace the cover screw.



Caution: Do not over-tighten the cover screw because this can damage the 'O'-ring seal.

4.3.2 To adjust the gain using a Güralp Minimus digitiser

Ensure that the switch is set to position three (3) and then open the web page of the Minimus. Click the Setup tab:

Ensure that the “Sensor type” drop-down menu is set to Fortis...

Analogue Sensors			
Analogue to Digital Converter			
Input gain	x1.0	Input range	+/- 20.48 V
		Input resolution	2.441 uV/count
Identification			
Sensor type	Guralp Fortis		
Response			
Fortis Range	Guralp 3T	Fortis Loop	Normal
	Guralp 3ESPC		
	Guralp 40T		
Mass Centring			
Centre Mass	Guralp Fortis	Mass Readout Z	-0.00375 V
	Guralp 5TC	Mass Readout N	-0.00312 V
	Guralp 6T	Mass Readout E	-0.00375 V
Calibration			
	Guralp 3TB	Amplitude	100%
	Guralp 3V/3ESP-V	Channel	Normal
	Guralp 3T5TB		
	Guralp 54T		
	Generic velocity		
	Generic acceleration		
Selection			
Guralp Systems Limited Midas House, Calleva Park, Aldermaston, Reading, RG7 8EA, UK Tel: +44 118 981 9056, Fax: +44 118 981 9943 E-Mail: sales@guralp.com , support@guralp.com			

... then select the desired gain from the “Fortis Range” drop-down menu:

Analogue Sensors			
Analogue to Digital Converter			
Input gain	x1.0	Input range	+/- 20.48 V
		Input resolution	2.441 uV/count
Identification			
Sensor type	Guralp Fortis		
Response			
Fortis Range	-2.0g; +2.0g	Fortis Loop	Normal
	-0.5g; +0.5g		
	-1.0g; +1.0g		
Mass Centring			
Centre Mass	-2.0g; +2.0g	Mass Readout Z	-0.00375 V
	-4.0g; +4.0g	Mass Readout N	-0.00312 V
		Mass Readout E	-0.00375 V
Calibration			
		Amplitude	100%
		Channel	Normal

The new gain setting takes effect immediately.



Note: This technique *only* works correctly if the physical gain-control switch on the instrument is set to position three (3).

4.3.3 To adjust the gain using the control lines

1. Ensure that the gain-selection switch is set to position three (3), as described in the previous section;
2. Consult the table below to choose whether each of “Select 0” and “Select 1” should be “high” or “low”.

Select 0	Select 1	Amplifier gain	Full-scale (g)	Equivalent switch position
low	low	8	0.5	0
low	high	4	1	1
high	low	2	2	2
high	high	1	4	3

- Pins that are to be “high” should be left floating – i.e. not connected at all. An internal resistor pulls the corresponding line up to a positive voltage. Pins that are to be “low” should be grounded by connecting them to pin N.

Pin-out details are given in Section 7 on page 31.

4.3.4 Gain interaction

Güralp do not recommend attempting to use more than one gain control method simultaneously. The following information is provided for completeness only.

The gain control switch acts directly on the two gain control lines, “Select 0” and “Select 1”, grounding neither, one or both as appropriate. The following table shows the effect of using both the physical switch on the instrument and the control lines at the same time.

Switch	Select 0	Select 1	Amplifier Gain	Full-scale (g)	?
3	high	high	1	4	✓
	high	low	2	2	✓
	low	high	4	1	✓
	low	low	8	0.5	✓
2	high	ignored	2	2	?
	low		8	0.5	?
1	ignored	high	4	1	?
		low	8	0.5	?
0	ignored	ignored	8	0.5	?

The following table shows the effect of using the physical switch on the instrument and the web page of a Güralp Minimus digitiser simultaneously:

Switch	Minimus (web) setting	Amplifier Gain	Full-scale (g)	?
0	ignored	8	0.5	?
1	Unity	4	1	✗
	×2	8	0.5	✗
	×4	4	1	✓
	×8	8	0.5	✓
2	Unity	2	2	✗
	×2	2	2	✓
	×4	8	0.5	✗
	×8	8	0.5	✓
3	Unity	1	4	✓
	×2	2	2	✓
	×4	4	1	✓
	×8	8	0.5	✓

4.4 Output polarity

The polarity of output from each component of the instrument is as follows:

Direction of ground acceleration	Polarity of Z output	Polarity of N/S output	Polarity of E/W output
Upwards	positive	zero	zero
Downwards	negative	zero	zero
Northwards	zero	positive	zero
Southwards	zero	negative	zero
Eastwards	zero	zero	positive
Westwards	zero	zero	negative

If the ground accelerates northwards, this moves the casing of the instrument northwards, and the N-axis inertial mass is left behind. From the instrument's frame of reference, the mass appears to have been deflected southwards. The feedback system then needs to provide a balancing force to accelerate it northwards and this, by design, will result in a positive output signal from the N/S component.

If the instrument is mounted with the 'N' arrow pointing downwards, gravity will try and pull the inertial mass in the direction of the instrument's N-axis.

The feedback system then provides a balancing force to accelerate it upwards which, from the instrument's frame of reference, is now southwards. This is the opposite of the previous situation, so the output from the N/S component will now be negative.

The converses are also true: if the ground accelerates southwards, the instrument will produce a negative output signal from the N/S component and if the instrument is orientated with its 'N' arrow pointing upwards, it will produce a positive output signal from the N/S component

The polarity of the output signals with respect to acceleration can be demonstrated by selecting a sensitivity of 1 g, 2 g or 4 g and orientating the instrument as shown in the following diagram:

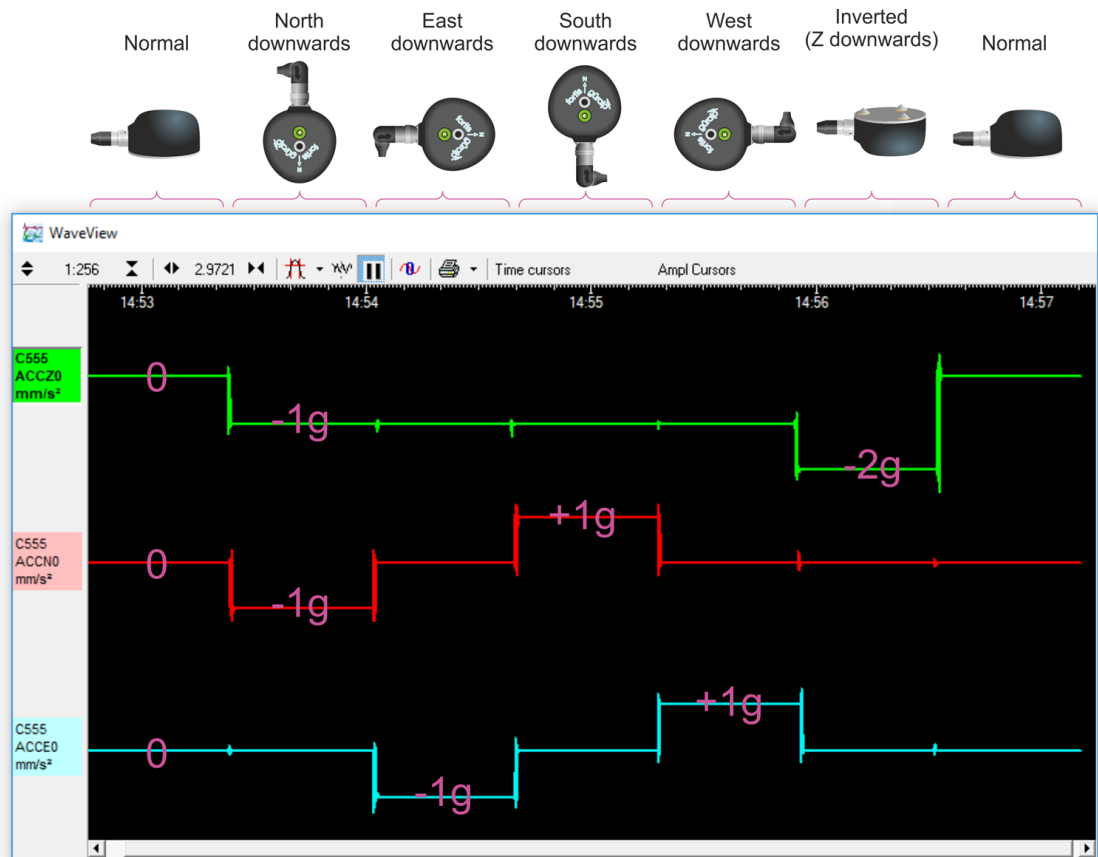

4.5 Use with third-party digitisers

A "pig-tail" cable, terminated at one end only, is available for use with third-party digitisers. The Fortis and Fortis^{PH}'s industry-standard differential ± 10 V outputs (sometimes referred to as 40 V peak-to-peak) are compatible with most third-party digitisers. If a digitiser with non-balanced (single-ended) inputs is used, leave the inverting output pins, B, D and F unconnected and double the calibration values (because the digitiser is now only seeing half of the signal).

5 Installation

5.1 Permanent installations

You will need a hard, clean surface such as a concrete floor, to install the Fortis.

If you are in any doubt about how to install the sensor, you should contact Güralp Systems' Technical Support, via support@guralp.com.

1. Prepare the surface by scribing an accurate N/S orientation line and installing a grouted-in fixing bolt on the line, near the middle. An anchor terminating in a 6 mm or 8 mm ($\frac{1}{4}$ or $\frac{5}{16}$ inch) threaded stud is suitable. The exposed thread should project approximately 120 mm (4½ inches) above the surface. Significant excess length should be removed.

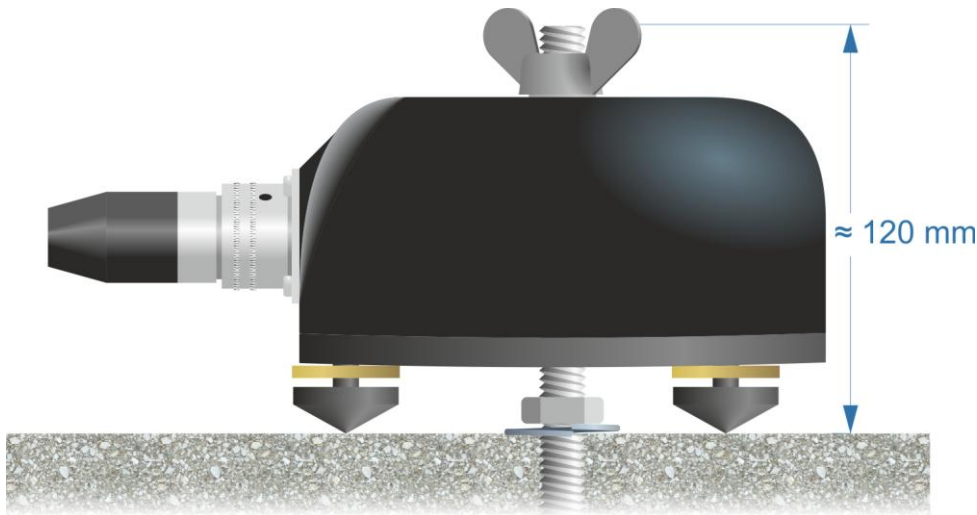

2. Place the accelerometer over the fixing bolt and rotate to bring the orientation line and pointers accurately into registration with the scribed base-line.

For more accurate alignment, a long, thin rod or a length of stiff wire can be aligned with a slot machined into the base of the instrument. It can be held in place by hand or, if preferred, by inserting two 3mm screws into the threaded holes provided.

3. Level the sensor, using its adjustable feet, until the bubble lies entirely within the inner circle of the level indicator.

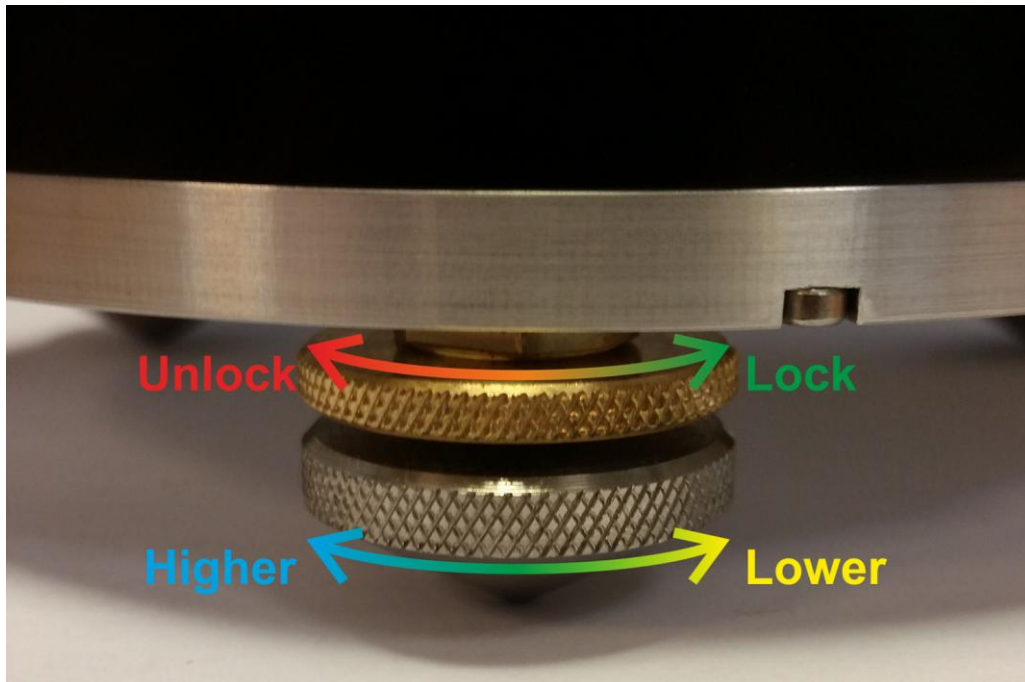

The feet are mounted on screw threads. To adjust the height of a foot, turn the brass locking nut clockwise (when viewed from above) to loosen it and rotate the entire foot so that it screws either in or out. When you are happy with the height, tighten the brass locking nut anti-clockwise (when viewed from above) to secure the foot.

4. Secure the instrument to the mounting stud using a wing-nut.



Caution: Hand-tighten only: do not use tools.

5. Connect a Güralp sensor cable between the instrument and your Güralp Affinity or other Güralp digitiser.

Alternatively: connect a Güralp “pig-tail” cable between the instrument and your own recording equipment, using the pin-out details in Section 7 on page 31.

6. Power on the digitiser.

The instrument is now installed and transducing ground motion.

5.2 Temporary installations

The Fortis is ideal for monitoring vibrations at field sites, owing to its ruggedness, high sensitivity and ease of deployment. Temporary installations will usually be in hand-dug pits or machine-augured holes. Once a level base is made, the accelerometer can be sited there and covered with a box or bucket.

One way to produce a level base is to use a hard-setting liquid:

1. Prepare a quick-setting cement/sand mixture and pour it into the hole.

2. "Puddle" the cement by vibrating it until it is fully liquefied, allowing its surface to level out.
3. Follow the cement manufacturer's instructions carefully. Depending on the temperature and type of cement used, the mixture will set over the next 2 to 12 hours.
4. Install the sensor as above, then cover and back-fill the emplacement with soil, sand, or polystyrene beads.
5. Cover the hole with a turf-capped board to exclude wind noise and to provide a stable thermal environment.

If you prefer, you can use quicker-setting plaster or polyester mixtures to provide a mounting surface. However, you must take care to prevent the liquid leaking away by "proofing" the hole beforehand. Dental plaster, or similar mixtures, may need reinforcing with sacking or muslin.

5.3 Installation in Hazardous environments

The fully enclosed, aluminium case design of the Fortis makes it suitable for use in hazardous environments where electrical discharges due to the build-up of static charge could lead to the ignition of flammable gasses. To ensure safe operation in these conditions, the metal case of the instrument must be electrically bonded ('earthed') to the structure on which it is mounted, forming a path to safely discharge any static charge.

Where electrical bonding ('earthing') is required during the installation of a Fortis, the central mounting hole that extends through the instrument should be used as the connection point. This is electrically connected to all other parts of the sensor case. Connection can be made by either a cable from a local earthing point terminated in an 8 mm ring tag or via the mounting bolt itself.

6 Calibration

The Fortis is supplied with a comprehensive calibration document, and it should not normally be necessary to calibrate it yourself. However, you may want to check that the response and output signal levels of the sensor are consistent with the values given in the calibration document.

6.1 Absolute calibration

The sensor's response (in V/ms^{-2}) is measured at the production stage by tilting the sensor through 90° and measuring the acceleration due to gravity. In addition, sensors are subjected to the "wagon wheel" test, where they are slowly rotated about a horizontal axis. The output of the sensor traces out a sinusoid over time, which is calibrated at the factory to range smoothly from 1 g to -1 g without clipping.

6.2 Relative calibration

The response of the sensor, together with several other variables, is measured at the factory. The values obtained are documented on the sensor's calibration sheet. Using these, you can convert directly from voltage (or counts, as measured in Scream!) to acceleration values and back. You can check any of these values by performing calibration experiments.

Güralp sensors and digitisers are calibrated in the following way:

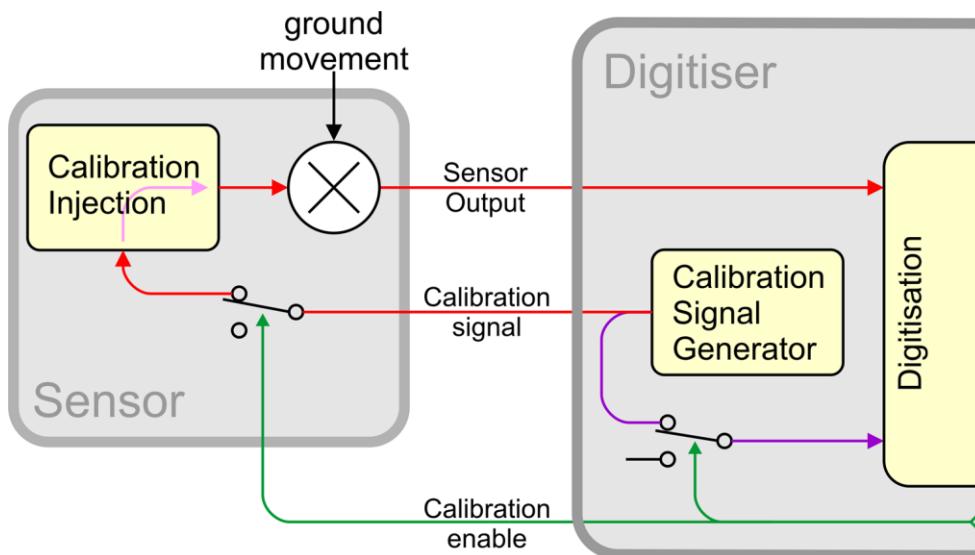

In this diagram, a Güralp digitiser is being used to inject a calibration signal into the sensor. This can be either a sine wave, a step function or broad-band noise, depending on your requirements. As well as going to the sensor, the calibration signal is returned to the digitiser.

The signal injected into the sensor gives rise to an equivalent acceleration, which is added to the measured acceleration to provide the sensor output. Because the injection circuitry can be a source of noise, a “Calibration enable” line from the digitiser is provided, which disconnects the calibration circuit when it is not required. The Calibration Enable line must normally be allowed to float high. To enable calibration, the Calibration Enable line should be connected to ground.



Note: Instruments can be supplied where this logic is reversed. This is known as “active-high” logic. For active-high instruments, the Calibration Enable line should normally be grounded and only allowed to float high during calibrations.

Fortis instruments are tuned at the factory to produce -1 V of output for +1 V input on the calibration channel. For example, a Fortis with gain set to unity (4 g full-scale) has an acceleration response of 0.25 V/ms⁻² so it should produce -1 V output given a 1 V calibration signal (i.e. polarity-reversed), corresponding to 1/0.25 = 4 ms⁻² = 0.408 g of equivalent acceleration.

6.3 Calibrating the Fortis

Both the DM24 digitiser and Scream! software allow direct configuration and control of any attached Güralp instruments. For full information on how to use a DM24 series digitiser, please see its own documentation.

6.3.1 Broadband Noise calibration using Scream and CD24/DM24 digitiser.

To calibrate using Scream! and a Güralp CD24 or DM24 digitiser:

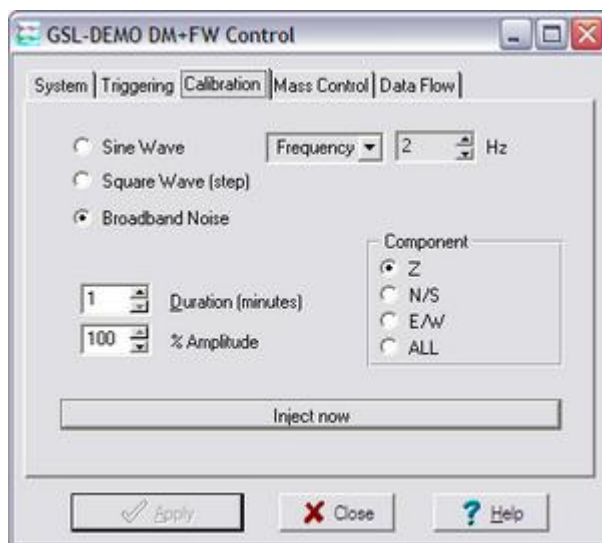

1. In Scream!'s main window, right-click on the digitiser's icon and select Control... In the resulting dialogue, select the Calibration tab.



2. Select "Broadband Noise" as the calibration type and, under Component, select "Z". This will calibrate all three components simultaneously.



Note: The Fortis has a single Calibration Line for all three components. Choices other than 'Z' will have undesired results.

3. Make any other choices you require and click Inject now. A new data stream, ending Cn (where n is an integer in the range 0 – 7) or MB, should appear in Scream!'s main window. This contains the returned calibration signal.
4. Open a WaveView window on the calibration signal and the returned streams by selecting them and double-clicking. The streams should display the calibration signal combined with the sensors' own measurements. If you cannot see the calibration signal, zoom into the WaveView using the scaling icons at the top left of the window or the cursor keys. If necessary, drag the calibration stream Cn up the WaveView window, so that it is at the top.
5. If the returning signal is saturated, retry using a calibration signal with lower amplitude, until the entire curve is visible in the WaveView window.
6. If you need to scale one, but not another, of the traces, right-click on the trace and select Scale.... You can then type in a suitable scale factor for that trace.
7. Pause the WaveView window by clicking on the  icon.
8. Hold down the SHIFT key () and drag across the window to select the calibration signal and the returning component(s). Release the mouse button, keeping SHIFT held down. A menu will pop up. Choose Broadband Noise Calibration.

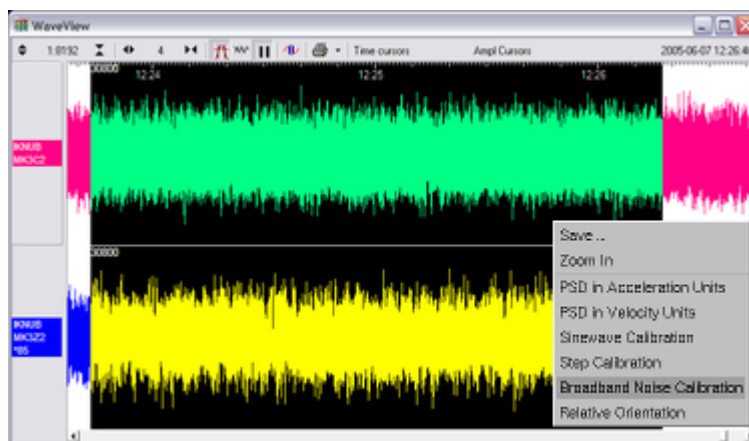

9. The script will ask you to fill in sensor calibration parameters for each component you have selected.

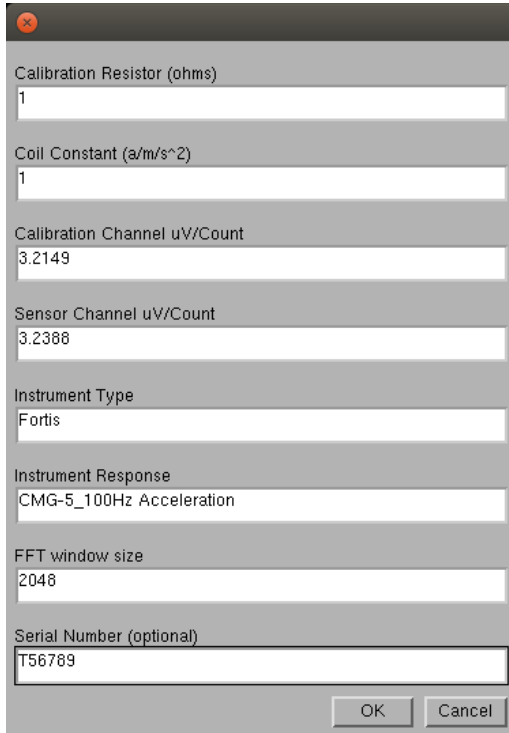

The screenshot shows a dialog box with the following fields and values:

- Calibration Resistor (ohms): 1
- Coil Constant (a/m/s²): 1
- Calibration Channel uV/Count: 3.2149
- Sensor Channel uV/Count: 3.2388
- Instrument Type: Fortis
- Instrument Response: CMG-5_100Hz Acceleration
- FFT window size: 2048
- Serial Number (optional): T56789

Buttons for 'OK' and 'Cancel' are visible at the bottom right.

10. Fill in the form as follows:

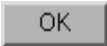
- “Calibration Resistor” should be set to 1
 - “Coil Constant” should be set to 1
 - The “Calibration Channel” sensitivity can be found on the calibration sheet for your digitiser.
 - The “Sensor Channel” sensitivity for the appropriate axis can be found on the calibration sheet for your digitiser.
 - “Instrument Type” should be set to “Fortis”.
 - “Instrument response” should be set to CMG-5_100Hz Acceleration
 - The Number of FFTs is calculated automatically and need not normally be overwritten.
 - The serial number can be filled in if desired: it is printed on the resulting graph.
11. Click . The script will return with a graph showing the response of the sensor in terms of amplitude and phase plots for each component. The accuracy of the results depends on the amount of data you have selected, and its sample rate.

To obtain good-quality results at low frequency, it will save computation time to use data collected at a lower sample rate; although the same information is present in higher-rate streams, they also include a large amount of high-frequency data which may not be relevant to your purposes.

- The noise calibration script automatically performs appropriate averaging to reduce the effects of aliasing and cultural noise.

The duration should be long enough to capture many periods of the lowest-frequency signal of interest. As a guide, allow one minute for each second of the lowest frequency for which you want accurate results. If, for instance, you are analysing signals with a period of 30 seconds, calibrate for at least half an hour.

If you prefer, you can inject your own signals into the system at any point (together with a Calibration enable signal, if required) to provide independent measurements and to check that the voltages around the calibration loop are consistent. For reference, a DM24-series digitiser will generate a calibration signal of around 16,000 counts (4 V) when set to 100% (sinewave or step) and around 10,000 counts (2.5 V) when set to 50%.

6.3.2 Broadband Noise calibration using Affinity digitiser.

To calibrate using an Affinity digitiser:

- In Affinity webpage, go to Control → Instruments and select the Calibration tab.

Masses Calibration

Sine wave
 Step signal
 Broadband noise

All components simultaneously
 Z (vertical)
 N (North/South)
 E (East/West)

Frequency (f in Hz)
1.0

Amplitude (1-100%)
100



Duration (d in seconds)
300

Begin calibration signal generation

- Select "Broadband noise" as the calibration type and, under Component, select "Z". This will calibrate all three components simultaneously.



Note: The Fortis has a single Calibration Line for all three components. Choices other than 'Z' will have undesired results.

3. Make any other choices you require (amplitude, and duration) and click Inject now. A new data stream, ending C_n (where n is an integer in the range 0 – 7) or MB, should appear in Scream!'s main window. This contains the returned calibration signal.
4. In Scream, open a WaveView window on the calibration signal and the returned streams by selecting them and double-clicking. The streams should display the calibration signal combined with the sensors' own measurements. If you cannot see the calibration signal, zoom into the WaveView using the scaling icons at the top left of the window or the cursor keys. If necessary, drag the calibration stream C_n up the WaveView window, so that it is at the top.
5. If the returning signal is saturated, retry using a calibration signal with lower amplitude, until the entire curve is visible in the WaveView window.
6. If you need to scale one, but not another, of the traces, right-click on the trace and select Scale.... You can then type in a suitable scale factor for that trace.
7. Pause the WaveView window by clicking on the  icon.
8. Hold down the SHIFT key () and drag across the window to select the calibration signal and the returning component(s). Release the mouse button, keeping SHIFT held down. A menu will pop up. Choose Broadband Noise Calibration.

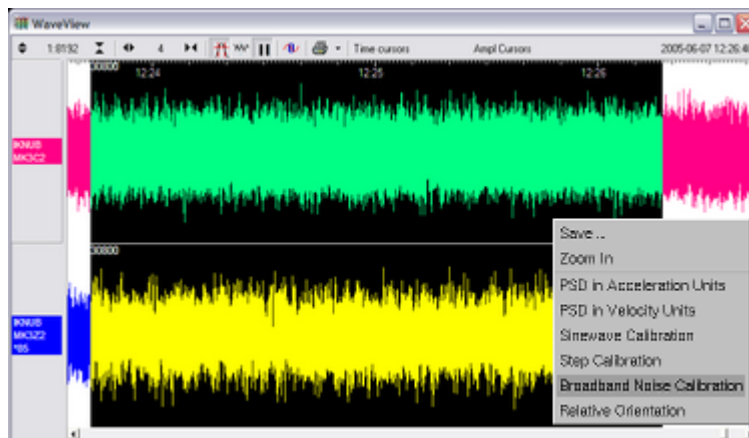

- The script will ask you to fill in sensor calibration parameters for each component you have selected.

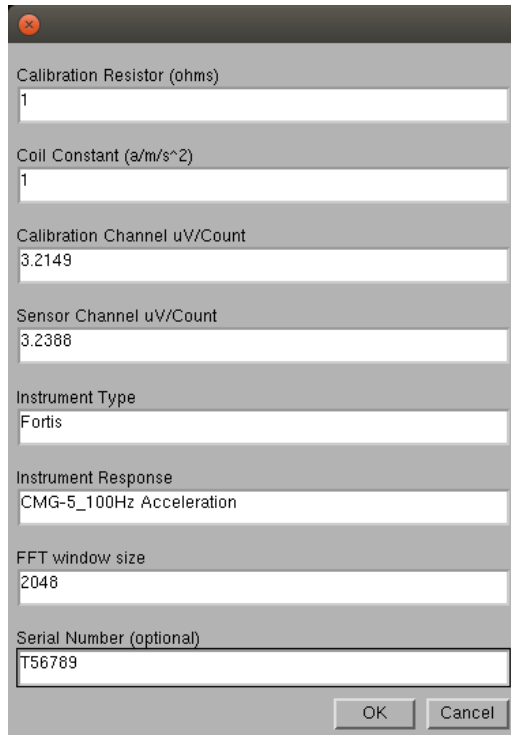

A screenshot of a software dialog box for sensor calibration. The dialog has a title bar with a close button (X). It contains several input fields with labels and values:

- Calibration Resistor (ohms): 1
- Coil Constant (a/m/s²): 1
- Calibration Channel uV/Count: 3.2149
- Sensor Channel uV/Count: 3.2388
- Instrument Type: Fortis
- Instrument Response: CMG-5_100Hz Acceleration
- FFT window size: 2048
- Serial Number (optional): T56789

At the bottom right, there are two buttons: "OK" and "Cancel".

- Fill in the form as follows:

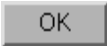
- "Calibration Resistor" should be set to 1
 - "Coil Constant" should be set to 1
 - The "Calibration Channel" sensitivity can be found on the calibration sheet for your digitiser.
 - The "Sensor Channel" sensitivity for the appropriate axis can be found on the calibration sheet for your digitiser.
 - "Instrument Type" should be set to "Fortis".
 - "Instrument response" should be set to CMG-5_100Hz Acceleration
 - The Number of FFTs is calculated automatically and need not normally be overwritten.
 - The serial number can be filled in if desired: it is printed on the resulting graph.
- Click . The script will return with a graph showing the response of the sensor in terms of amplitude and phase plots for each component. The accuracy of the results depends on the amount of data you have selected, and its sample rate.

To obtain good-quality results at low frequency, it will save computation time to use data collected at a lower sample rate; although the same information is present in higher-rate streams, they also include a large amount of high-frequency data which may not be relevant to your purposes.

- The noise calibration script automatically performs appropriate averaging to reduce the effects of aliasing and cultural noise.

The duration should be long enough to capture many periods of the lowest-frequency signal of interest. As a guide, allow one minute for each second of the lowest frequency for which you want accurate results. If, for instance, you are analysing signals with a period of 30 seconds, calibrate for at least half an hour.

6.3.3 White Noise calibration using Minimus

To calibrate using a Minimus digitiser:

- Go to the Setup tab of the web page and use the drop-down menu to choose White Noise signal to be injected into the sensor's feedback loop.

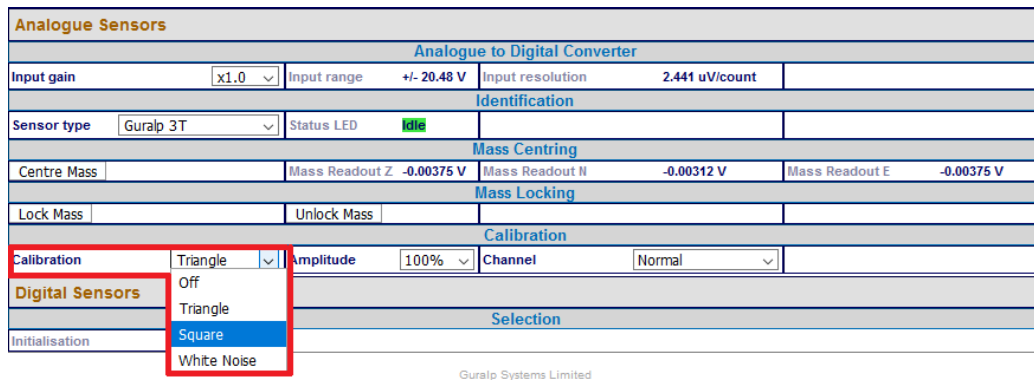

- Adjust the calibration signal amplitude at 100%, 50%, 25% or 12.5% of the DAC full range.

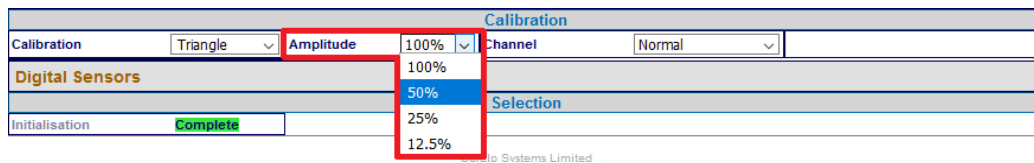

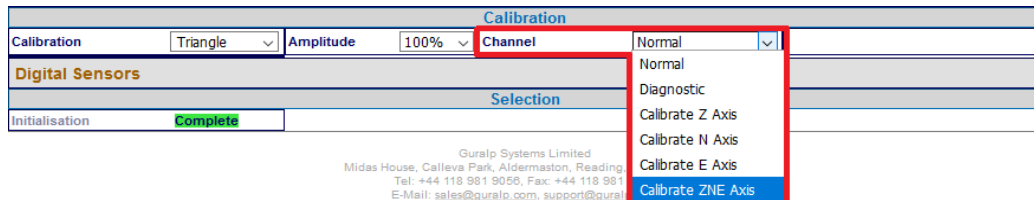

- Finally, enable the calibration on all three components of the Fortis.

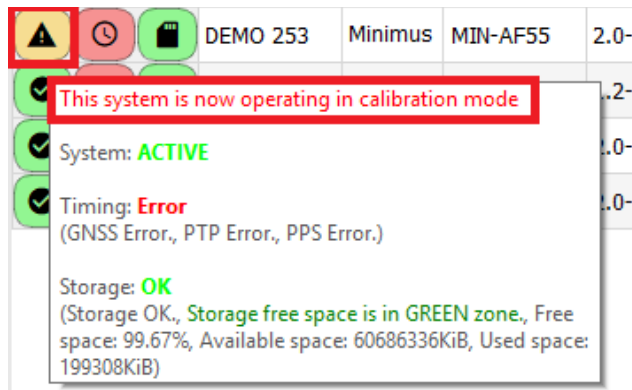

Note: The calibration channel, named nACCC0, produces an output if and only if the calibration is in progress.

While the calibration is in progress, the web-page shows the warning message **Calibration in progress** and Discovery flags the status icon in yellow:



4. In Scream, open a WaveView window on the calibration signal and the returned streams by selecting them and double-clicking. The streams should display the calibration signal combined with the sensors' own measurements. If you cannot see the calibration signal, zoom into the WaveView using the scaling icons at the top left of the window or the cursor keys. If necessary, drag the calibration stream nACCC0 up the WaveView window, so that it is at the top.
5. If the returning signal is saturated, retry using a calibration signal with lower amplitude, until the entire curve is visible in the WaveView window.
6. If you need to scale one, but not another, of the traces, right-click on the trace and select Scale... You can then type in a suitable scale factor for that trace.
7. Pause the WaveView window by clicking on the  icon.
8. Hold down the SHIFT key () and drag across the window to select the calibration signal and the returning component(s). Release the mouse button, keeping SHIFT held down. A menu will pop up. Choose Broadband Noise Calibration.

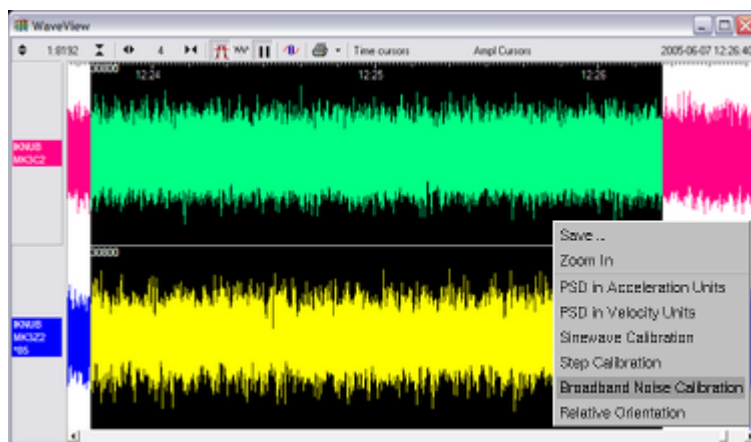

9. The script will ask you to fill in sensor calibration parameters for each component you have selected.

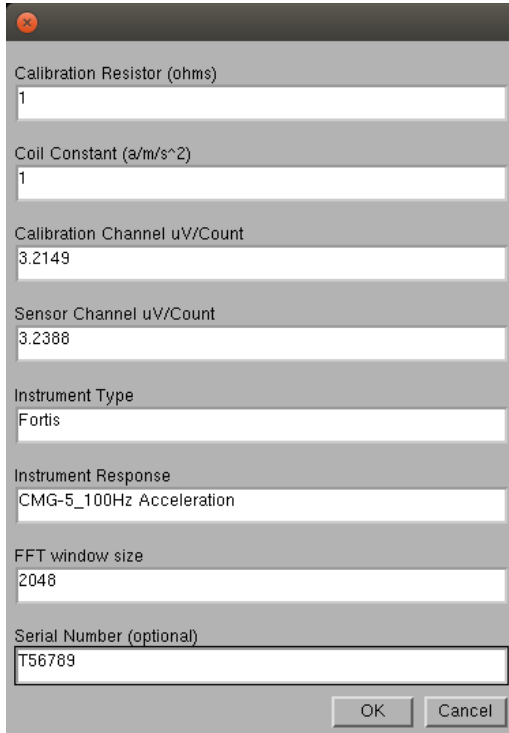

A screenshot of a software dialog box for sensor calibration. The dialog has a title bar with a close button (X). It contains several input fields with labels and values:

- Calibration Resistor (ohms): 1
- Coil Constant (a/m/s²): 1
- Calibration Channel uV/Count: 3.2149
- Sensor Channel uV/Count: 3.2388
- Instrument Type: Fortis
- Instrument Response: CMG-5_100Hz Acceleration
- FFT window size: 2048
- Serial Number (optional): T56789

At the bottom right, there are two buttons: "OK" and "Cancel".

10. Fill in the form as follows:

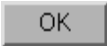
- a) "Calibration Resistor" should be set to 1
 - b) "Coil Constant" should be set to 1
 - c) The "Calibration Channel" sensitivity can be found on the calibration sheet for your digitiser.
 - d) The "Sensor Channel" sensitivity for the appropriate axis can be found on the calibration sheet for your digitiser.
 - e) "Instrument Type" should be set to "Fortis".
 - f) "Instrument response" should be set to CMG-5_100Hz Acceleration
 - g) The Number of FFTs is calculated automatically and need not normally be overwritten.
 - h) The serial number can be filled in if desired: it is printed on the resulting graph.
11. Click . The script will return with a graph showing the response of the sensor in terms of amplitude and phase plots for each component. The accuracy of the results depends on the amount of data you have selected, and its sample rate.

To obtain good-quality results at low frequency, it will save computation time to use data collected at a lower sample rate; although the same information is present in higher-rate streams, they also include a large amount of high-frequency data which may not be relevant to your purposes.

12. The noise calibration script automatically performs appropriate averaging to reduce the effects of aliasing and cultural noise.
13. The duration should be long enough to capture many periods of the lowest-frequency signal of interest. As a guide, allow one minute for each second of the lowest frequency for which you want accurate results. If, for instance, you are analysing signals with a period of thirty seconds, calibrate for at least half an hour.

6.3.4 Calibration with third-party digitisers

The Fotis and Fortis^{PH} can be calibrated when a third-party digitiser is being used.

- To calibrate a Fortis: Connect the calibration enable line, pin R, to ground, pin N. Apply a calibration signal of around ± 2.5 V between pins P and N.
- To calibrate a Fortis^{PH}: Connect the calibration enable line, pin R, to logic ground, pin Y. Apply a calibration signal of around ± 2.5 V between pins P and N.

Some third-party digitisers can be programmed to make the necessary connections

6.4 The calibration pack

All Güralp sensors are fully calibrated before they leave the factory. Both absolute and relative calibration calculations are carried out. The results are given in the calibration pack supplied with each instrument.

6.4.1 The calibration sheet

The calibration sheet provides the measured acceleration output over the flat portion of the sensor frequency response in units of volts per metre per second squared (V/ms^{-2}). Because the sensor produces outputs in differential form (also known as push-pull or balanced output), the signal received from the instrument by a recording system with a differential input will be twice the true value. For example, the calibration sheet may give the acceleration response as “2 x 0.50 V/ms^{-2} ”, indicating that this factor of 2 was not included in the value given.



Caution: Never ground any of the differential outputs. If you are connecting to a single-input recording system, you should use the signal ground line as the return line and ignore the inverting output.

6.4.2 Frequency response

The poles and zeroes table describes the frequency response of the sensor. If required, you can use the poles and zeroes to derive the true ground motion mathematically from the signal received at the sensor. The Fortis is designed to provide a flat response (to within 3dB) over its passband.

Güralp Systems performs frequency response tests on every sensor at the time of manufacture. All records are archived for future reference. The results of these tests are provided with the sensor.

When testing the instrument to confirm that it meets its design specification, the range of frequencies used are concentrated over about 3 decades (i.e. 1000 : 1) of excitation frequencies. Consequently, the frequency plots of each component are provided in normalised form. Each plot marks the frequency cut-off value (often quoted as “-3dB” or “half-power” point).

6.4.3 Obtaining copies of the calibration pack

We keep a copy of all calibration data that we send out. In the event that the calibration information becomes separated from the instrument, you can obtain all the information using our free email service. Simply email caldoc@guralp.com with the serial number of the instrument in the subject line.

For example:

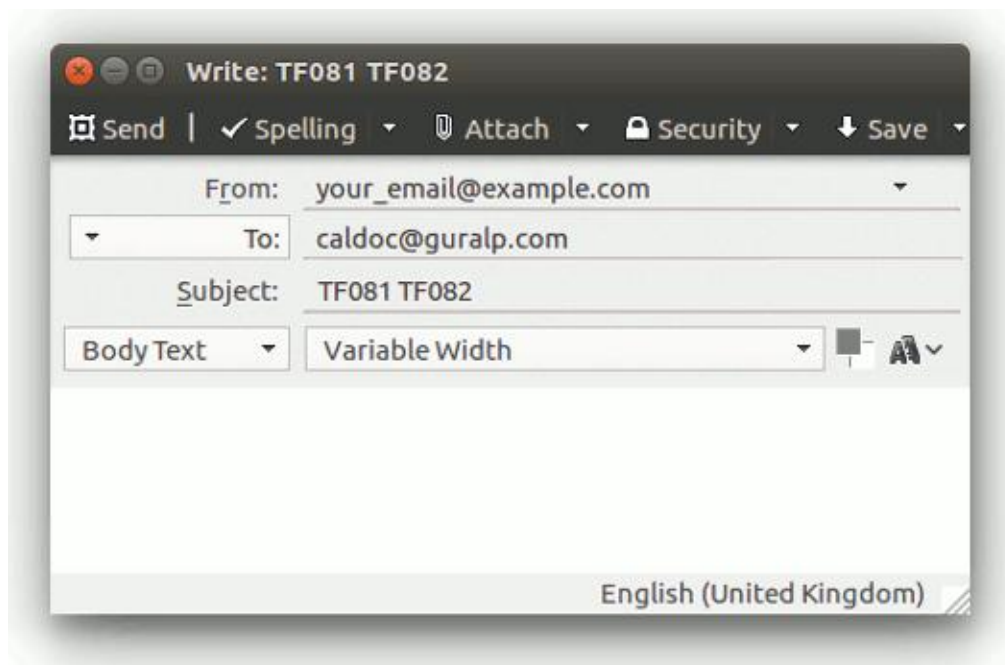

The server will reply with the calibration documentation in Word format. The body of your email will be ignored. If you need multiple documents, enter all the serial numbers in the subject line, separated with spaces and/or commas.

7 Appendix A – Connector pin-outs

7.1 Fortis instrument connector

This is a standard 26-pin military specification bayonet plug, conforming to MIL-DTL-26482 (formerly MIL-C-26482). A typical part-number is 02E-16-26P although the initial "02E" varies with manufacturer.

Suitable mating connectors have part-numbers like ***-16-26S and are available from Güralp Systems or directly from Amphenol, ITT Cannon and other manufacturers.



Pin	Function	Pin	Function
A	Vertical output: non-inverting	P	Calibration signal input
B	Vertical output: inverting	R	Calibration enable
C	N/S output: non-inverting	S	Sensitivity select 0 *
D	N/S output: inverting	T	Sensitivity select 1 *
E	E/W output: non-inverting	U	Centre
F	E/W output: inverting	V	<i>not connected</i>
G	<i>not connected</i>	W	Open loop
H	<i>not connected</i>	X	<i>not connected</i>
J	<i>not connected</i>	Y	<i>not connected</i>
K	<i>not connected</i>	Z	<i>not connected</i>
L	<i>not connected</i>	a	<i>not connected</i>
M	-V in (optional split power-supply)	b	0V in
N	Ground and casing	c	+V in

* see section 4.3 on page 10.

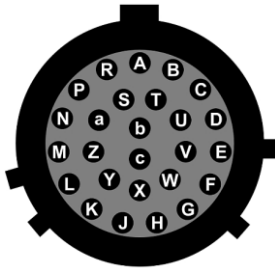

Wiring details for the compatible socket, ***-16-26S, as seen from the cable end (*i.e.* when assembling).

7.2 Fortis^{PH} instrument connector

This is a custom 32-pin plug with pin spacing and layout conforming to MIL-DTL-26482 (formerly MIL-C-26482). The GSL part number is ELM-32P-18FX+MEC-GEN-1002-32W.

Suitable mating connectors are only available from GSL as part of cable assemblies.

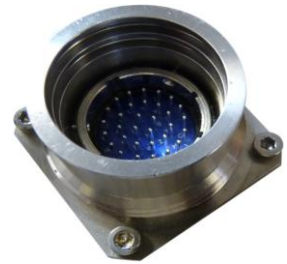

Pin	Function	Pin	Function
A	Vertical output: non-inverting	T	Sensitivity select 1 *
B	Vertical output: inverting	U	Centre
C	N/S output: non-inverting	V	<i>not connected</i>
D	N/S output: inverting	W	Open loop
E	E/W output: non-inverting	X	<i>not connected</i>
F	E/W output: inverting	Y	Digital ground
G	<i>not connected</i>	Z	<i>not connected</i>
H	<i>not connected</i>	a	<i>not connected</i>
J	<i>not connected</i>	b	0V in
K	<i>not connected</i>	c	+V in
L	<i>not connected</i>	d	<i>not connected</i>
M	-V in (optional split power-supply)	e	<i>not connected</i>
N	Signal ground	f	<i>not connected</i>
P	Calibration signal	g	<i>not connected</i>
R	Calibration enable	h	<i>not connected</i>
S	Sensitivity select 0 *	j	<i>not connected</i>

* see section 4.3 on page 10.



Wiring details for the compatible socket, MEC-GEN-2002-32W, as seen from the cable end (*i.e.* when assembling).

8 Appendix B – Certificate of conformance

EU Declaration of Conformity

We

Guralp Systems Ltd
Midas House, Calleva Park, Aldermaston
READING, RG7 8EA.

Tel: +44 118 981 9056
E-mail: technical@guralp.com

Declare under our sole responsibility that the following product

Equipment name: Fortis
Model Number: FOR-MAA101000G01L and appropriate variants
Serial Numbers: TF026 onwards

Is in conformity with the

Electromagnetic Compatibility Directive 2014/30/EU
Low Voltage Directive 2014/35/EU
Restriction of Hazardous Substances (RoHS) Directive 2011/65/EU

by applying the following harmonised standards and technical specifications:

- EMC: EN 61000-4-2:2009 – Electrostatic Discharge Immunity
- EN 61000-4-3:2006 +A1:2008 +A2:2010 – Radiated RF Immunity
- EN 61000-4-4:2012 – Electrical Fast Transients Immunity
- EN 61000-4-5:2014 – Voltage Surge Immunity
- EN 61000-4-6:2014 – Conducted RF Immunity
- EN 61000-4-8:2010 – Power Frequency Magnetic Field Immunity
- EN 61000-4-11:2004 – Voltage Dips and Short Interruptions Immunity
- EN 55011:2009 +A1:2010 – Radiated Emissions
- EN 55011:2009 +A1:2010 – Conducted Emissions
- EN 61000-3-2:2014 – Harmonic Current Emissions
- EN 61000-3-3:2013 – Voltage Fluctuations and Flicker

LVD: IEC 61010-1 3rd Edition

RoHS: 2011/65/EU

Signed for and on behalf of: Guralp Systems Ltd
Place of issue: Aldermaston
Date of Issue: 15/11/2017
Position: Engineering Director
Signature: *Phs*



CE

9 Revision History

L	2022-05-12	Removed spurious break-out box power pin-out Added "Use with third-party digitisers" Clarified calibration with third-party digitisers
K	2019-12-02	Removed Accessories section. Updated Calibration chapter. Updated Minimus web-page screenshots. Updated Initial testing. Added CE marking certificate.
J	2018-10-09	Corrected information about gain-setting switch.
H	2018-06-25	Renamed Phortis to Fortis ^{PH} and replaced images.
G	2018-06-20	Added polarity section, Phortis dimensions and missing cross-reference.
F	2018-06-06	Added Phortis chapter and connector pin-out.
E	2018-04-21	Removed spurious pin-out diagram.
D	2016-08-08	Modified Gain tables.
C	2016-05-31	Added gain interaction table.
B	2016-02-16	Expanded and corrected HCU section.
A	2016-01-25	Initial release.